

Spot Safety Project Evaluation

Spot Safety Project # 09-07-207

**Spot Safety Project Evaluation of Signal Modification
(Installation and Removal of Four-Section Flashing Yellow Arrow Signal Heads on NC 150)
and Westbound Left Turn Lane Installation on SR 1508
NC 150 at SR 1508 (Old Salisbury Road/Hickory Tree Road)
Davidson County**

Documents Prepared By:

Hatch Mott MacDonald for

Safety Evaluation Group
Traffic Safety Systems Management Section
Transportation Mobility and Safety Division
North Carolina Department of Transportation

Principal Investigator

Amy Faulkner

Amy Faulkner

11-1-2013

Date

Spot Safety Project Evaluation Documentation

Subject Location

Evaluation of Spot Safety Project Number 09-07-207 located at the intersection of NC 150 at SR 1508 (Old Salisbury Road/Hickory Tree Road) in Davidson County.

The signal inventory number is 09-0480 for this eight phase, actuated traffic signal.

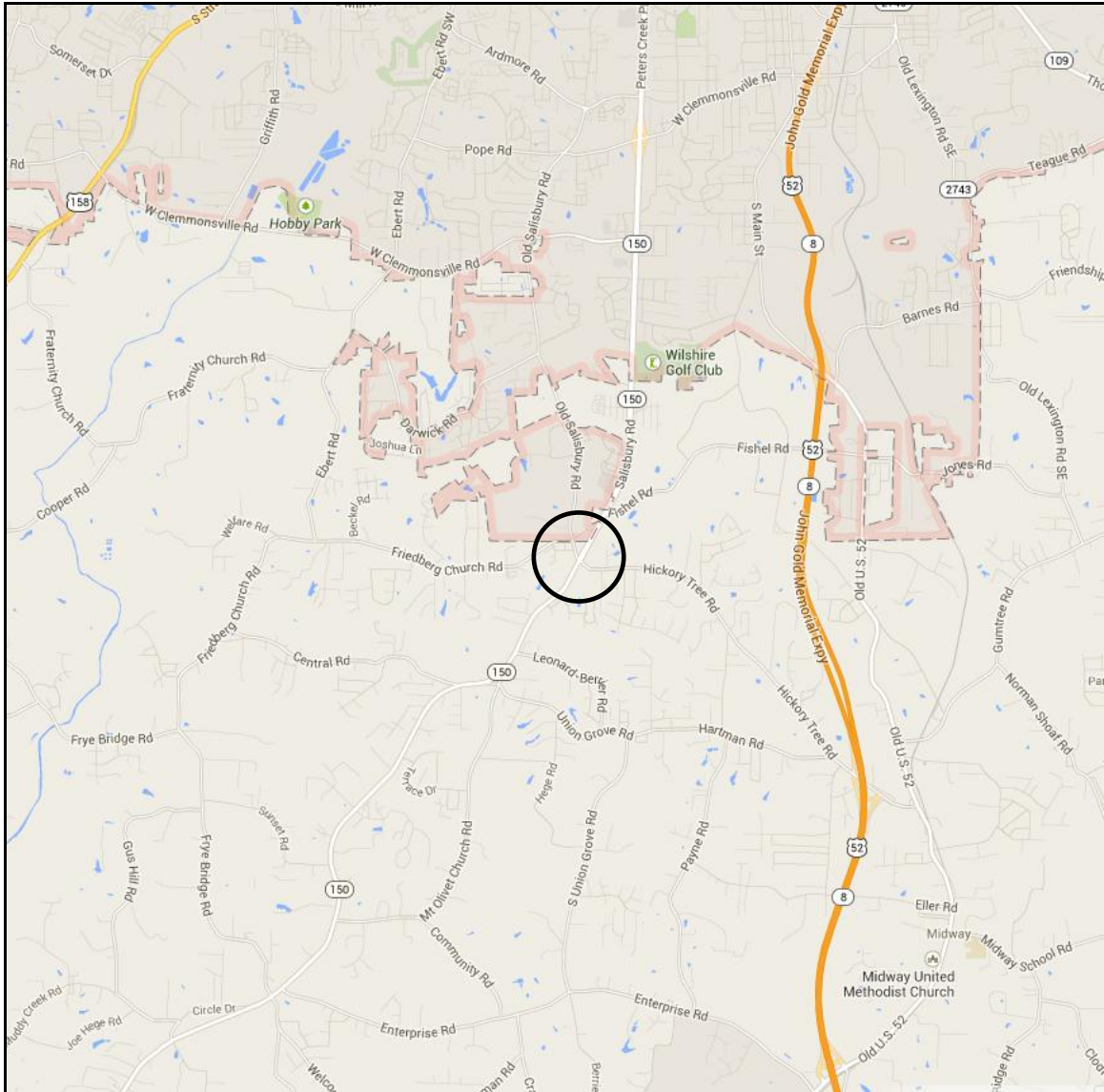

Map Provided from Google Maps

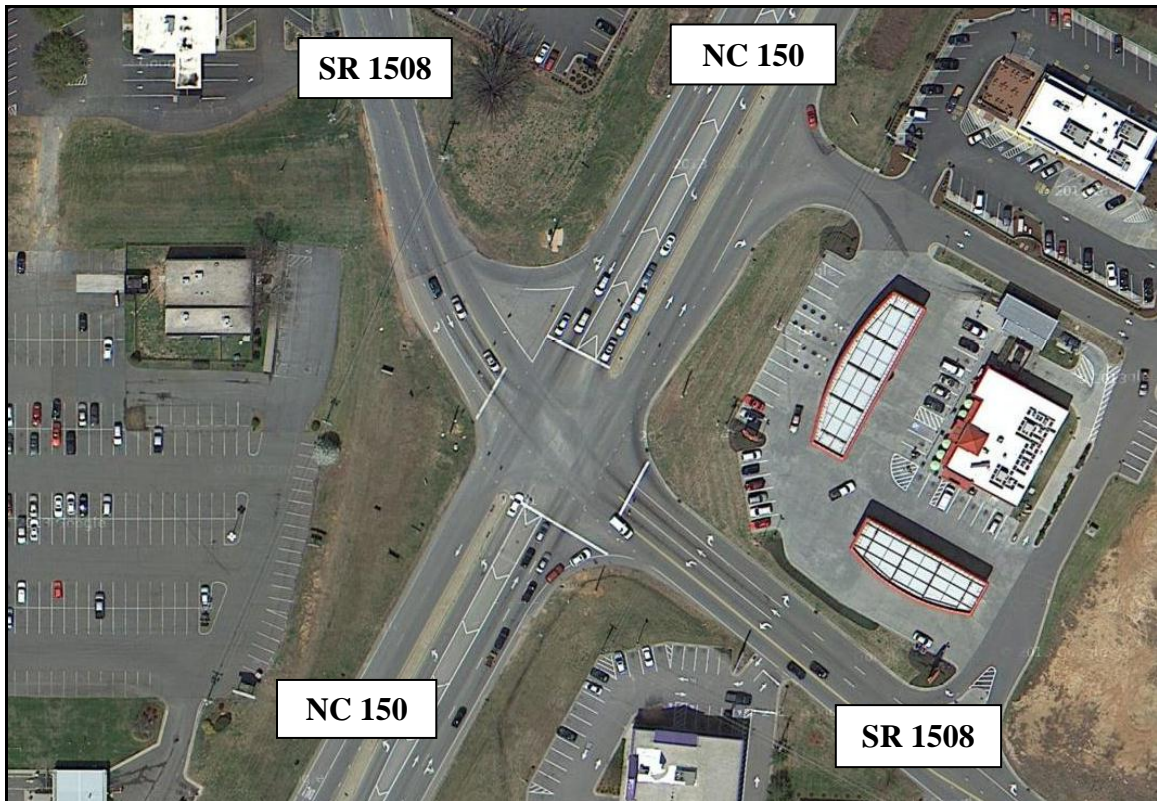

Aerial Photo Provided from Google Maps

Project Information and Background from the Project File Folder

The spot safety project improvement countermeasure chosen for the subject location was the installation of four-section signal heads with a flashing yellow arrow for the protected/permitted left turn movements from both NC 150 approaches. A left turn lane was also installed on the westbound approach of SR 1508. The signal was modified again on July 9, 2012. The permitted left turn phase was removed so that left turns from NC 150 are now fully protected.

NC 150 is a five lane facility with a center median and designated left turn lanes in both directions. The southbound approach has a right turn slip lane that is yield controlled. The eastbound SR 1508 (Old Salisbury Road) approach has designated left, through, and right lanes. The westbound SR 1508 (Hickory Tree Road) approach had an existing through and left lane and a designated right turn lane. The speed limit on NC 150 is 55 mph. The speed limit on SR 1508 is 45 mph.

The original statement of problem was that motorists are turning left from NC 150 onto SR 1508 during the permitted left turn signal phase and are being hit by vehicles traveling in the opposing direction on NC 150. The initial crash analysis was completed from December 1, 2001 to November 30, 2006 with thirty-five (35) reported left turn, same roadway crashes. The final completion date for the improvement at the subject intersection was on April 23, 2008 with a total cost of \$23,500.00.

Naive Before and After Analysis

After reviewing the spot safety project file folder along with all the crashes at the subject location, the crash data omitted from this analysis to consider for an adequate construction period were the months of April 2008 and July 2012. Due to the multiple countermeasures implemented at the study location, the analysis was split into the following time periods:

- Before Period: February 1, 2004 to March 31, 2008 (4 years, 2 months)
- After 1 Period (Flashing Yellow Arrow and Left Turn Lane Installation): May 1, 2008 to June 30, 2012 (4 years, 2 months)
- After 2 Period (Fully Protected Left Turns on NC 150): August 1, 2012 to August 31, 2013 (1 year, and 1 month)

The ending date for this analysis was determined by the date of available crash data at the time of analysis. The treatment data consists of all crashes within 150 feet of the intersection of NC 150 at SR 1508 (Old Salisbury Road/Hickory Tree Road) for all approaches. *Please see the above location map and aerial map for further details.*

The following data table depicts the Naive Before and After Analysis for the treatment location. Please note that the Target Crashes for the multiple countermeasure changes at this location are as follows:

- Target 1 – Left Turn Same Roadway (LTSR) crashes on NC 150.
- Target 2 – Left Turn related crashes involving vehicles turning left from the westbound SR 1508 (Hickory Tree Road) approach.

<u>Treatment Information</u>	Before 4 yrs., 2 mos.	After 1 4 yrs., 2 mos.	After 2 1 yr., 1mo.
Total Crashes	65	89	12
Total Crashes per Year	15.6	21.4	11.1
Total Severity Index	6.86	4.08	4.70
Target 1 Crashes (NC 150 LTSR)	24	26	0
Target 1 Crashes Per Year	5.8	6.2	0
Target 1 Crash Severity Index	8.78	5.84	0
Target 2 Crashes (WB Left Turn)	4	5	0
Target 2 Crashes Per Year	1.0	1.2	0
Target 2 Crash Severity Index	1	1	0
Volume (2006, 2010, 2012)	25,100	28,600	28,600

<u>Injury Crash Summary</u>	Before	After 1	After 2
Fatal injury Crashes	0	0	0
Class A injury Crashes	2	0	0
Class B injury Crashes	8	11	1
Class C Injury Crashes	23	26	5
Property Damage Only	32	52	6

The naive before and after analysis at the treatment location shows an increase in total crashes per year (cpy) from 15.6 cpy in the Before period to 21.4 cpy in the After 1 period. The number of total crashes per year decreased to 11.1 cpy in the After 2 period. The Left Turn Same Roadway Crashes on NC 150 (Target 1) increased from 5.8 cpy in the Before period to 6.2 cpy in the After 1 period, but was eliminated in the After 2 period. The Westbound Left Turn Crashes (Target 2) increased slightly from 1.0 cpy in the Before Period to 1.2 cpy in the After 1 Period with a zero (0) occurrence of these crashes in the After 2 period.

To further analyze the intersection crash patterns, the following chart shows different traffic movements and the change in crash totals through the study:

<u>Additional Information</u>	Before	After 1	After 2
Eastbound SR 1508 LTSR Crashes	7	8	0
EB SR 1508 LTSR Crashes Per Year	1.7	1.9	0
Southbound NC 150 U-turn Crashes	3	8	0
SB NC 150 U-turn Crashes Per Year	0.7	1.9	0

Results and Discussion

Referencing the *Collision Diagrams* and the above tables, the Total Crashes per year increased from the Before period to the After 1 period, but the Total Severity Index decreased from 6.86 in the Before period to 4.08 in the After 1 period. The After 2 period shows a decrease in Total Crashes per year, but it is important to note that this period represents a smaller data set.

The Target 1 crashes per year increased from 5.8 cpy in the Before period to 6.3 cpy in the After 1 period. The Severity Index decreased from 8.78 to 5.84 for these crashes, respectively. The Target 2 crashes did not show much change with 1.0 cpy in the Before period, 1.2 cpy in the After 1 period and zero (0) cpy in the After 2 period.

The *Additional Information Table* above displays information on other crash types at the study intersection. Left Turn Same Roadway Crashes involving vehicle turning left from eastbound SR 1508 increased slightly from 1.7 cpy in the Before period to 1.9 cpy in the After 1 period. Crashes involving vehicles making a U-turn from southbound NC 150 showed an increase from 0.7 cpy in the Before Period to 1.9 cpy in the After 1 period.

Please see the attached *Treatment Site Photos*. Photos are provided from Google Street View for all four approaches to the study intersection. As the Safety Evaluation Group facilitates additional spot safety reviews for these types of countermeasures, it is the goal to be able to provide objective and definite information regarding actual crash reduction factors for these types of treatments.

Treatment Site Photos from Google Street View



Google Maps (September 2012) – Looking South on NC 150 Approach



Google Maps (June 2008) – Looking North on NC 150 Approach



Google Maps (August 2012) – Looking East on SR 1508 Approach



Google Maps (August 2012) – Looking West on SR 1508 Approach

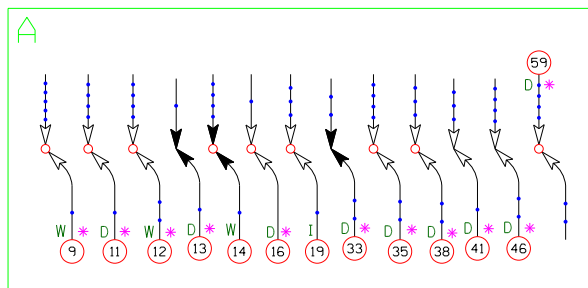

ADT (Year)
9,200 (2006)

NC 150
55 MPH

ADT (Year)
18,000 (2006)

ADT (Year)
10,000 (2006)

SR 1508
Old Salisbury Rd
45 MPH

SR 1508
Hickory Tree Rd
45 MPH

ADT (Year)
13,000 (2006)

NC 150
55 MPH

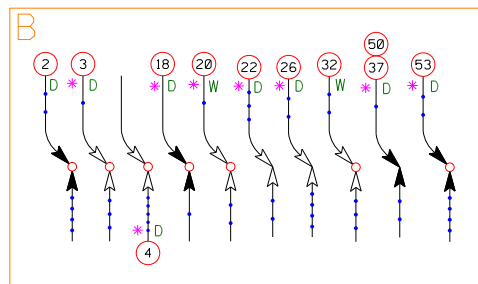

- # NC 150 Left Turn Same Roadway (Target 1)
- # Westbound Left Turn Crashes (Target 2)

LEGEND			
	MOVING VEHICLE		ANGLE
	PARKED VEHICLE		TURNING
	PARKING VEHICLE		BACKING
	MOVABLE OBJECT		SIDESWIPE
	HEAD ON		INJURY
	REAR END		FATALITY
	RAN OFF ROAD		9 MPH OR LESS
	DAYLIGHT CRASH		10 MPH TO 19
	NIGHT CRASH		20 MPH TO 29
	YIELD SIGN		30 MPH TO 39
	ANIMAL		40 MPH TO 49
	PEDESTRIAN		50 MPH TO 59
	BICYCLE		60 MPH TO 69
	TRAIN		70 AND UP
	DRIVER AT FAULT		SPEED UNKNOWN
	DRY		
	WET		
	ICY OR SNOWY		
	Other		

SS# 09-07-207
Davidson County
BEFORE Period
02/01/04 - 03/31/08

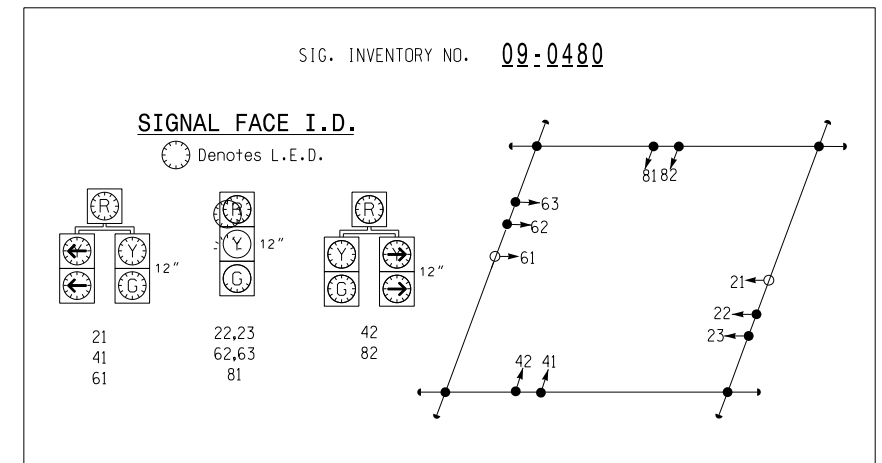

N.C. DEPARTMENT of TRANSPORTATION
DIVISION of HIGHWAYS
TRANSPORTATION MOBILITY and
SAFETY DIVISION

TRAFFIC SAFETY UNIT

Date: 11-1-13

Prepared By: Amy Faulkner, EI



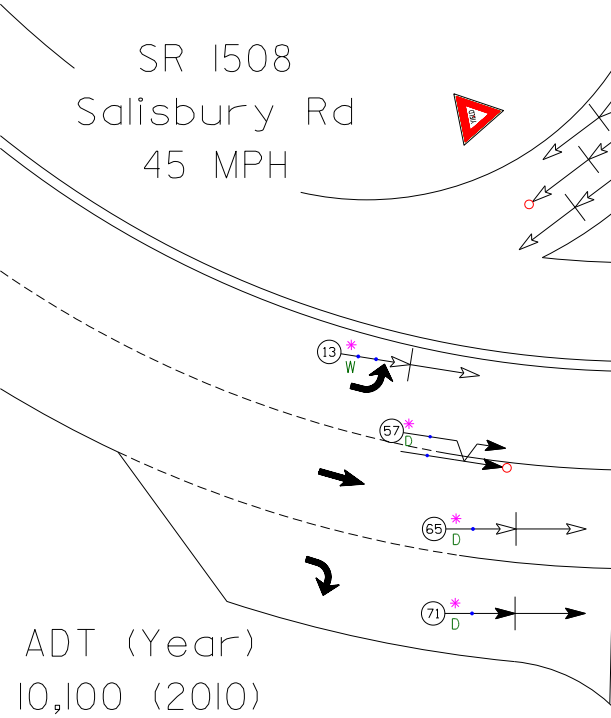
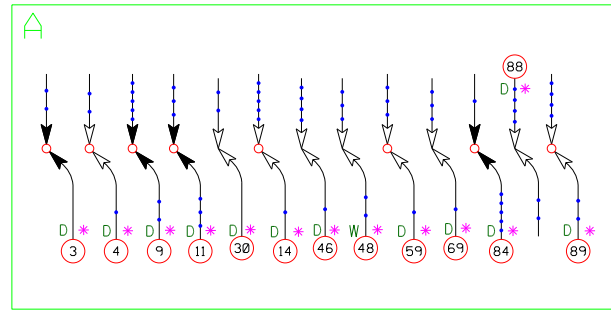

ADT (Year)
10,100 (2010)

ADT (Year)
14,000 (2010)

NC 150
55 MPH
ADT (Year)
21,000 (2010)

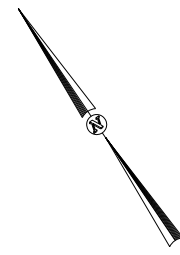

ADT (Year)
12,000 (2010)

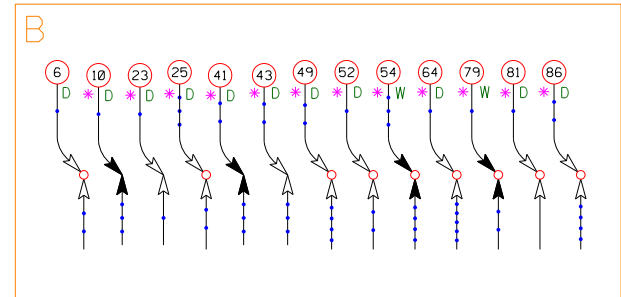

- # NC 150 Left Turn Same Roadway (Target 1)
- # Westbound Left Turn Crashes (Target 2)

LEGEND			
	MOVING VEHICLE		ANGLE
	PARKED VEHICLE		9 MPH OR LESS
	PARKING VEHICLE		10 MPH TO 19
	MOVABLE OBJECT		20 MPH TO 29
	HEAD ON		30 MPH TO 39
	REAR END		40 MPH TO 49
	RAN OFF ROAD		50 MPH TO 59
	DAYLIGHT CRASH		60 MPH TO 69
	NIGHT CRASH		70 AND UP
	YIELD SIGN		SPEED UNKNOWN
	ANIMAL		INJURY
	PEDESTRIAN		FATALITY
	BICYCLE		
	TRAIN		
	* DRIVER AT FAULT		
	D DRY		
	W WET		
	I ICY OR SNOWY		
	O Other		

SS# 09-07-207
Davidson County
After 1 Period
05/01/08 - 06/30/12

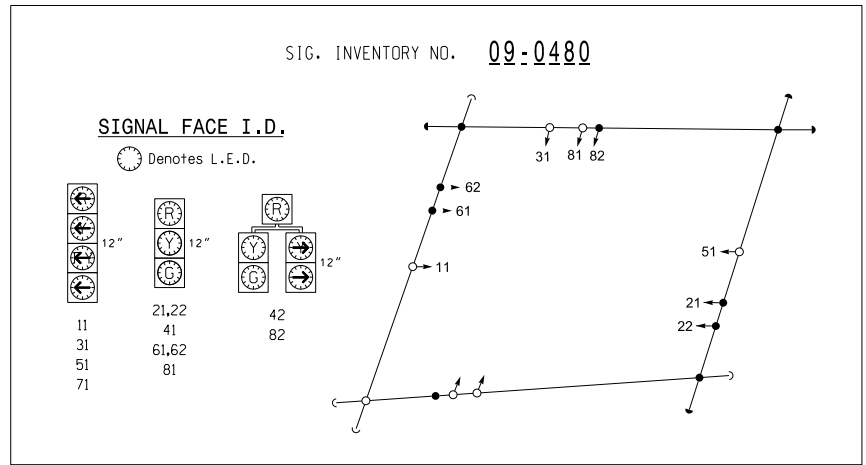

N.C. DEPARTMENT of TRANSPORTATION
DIVISION of HIGHWAYS
TRANSPORTATION MOBILITY and SAFETY DIVISION

TRAFFIC SAFETY UNIT

Date: 11-1-13

Prepared By: Amy Faulkner, EI



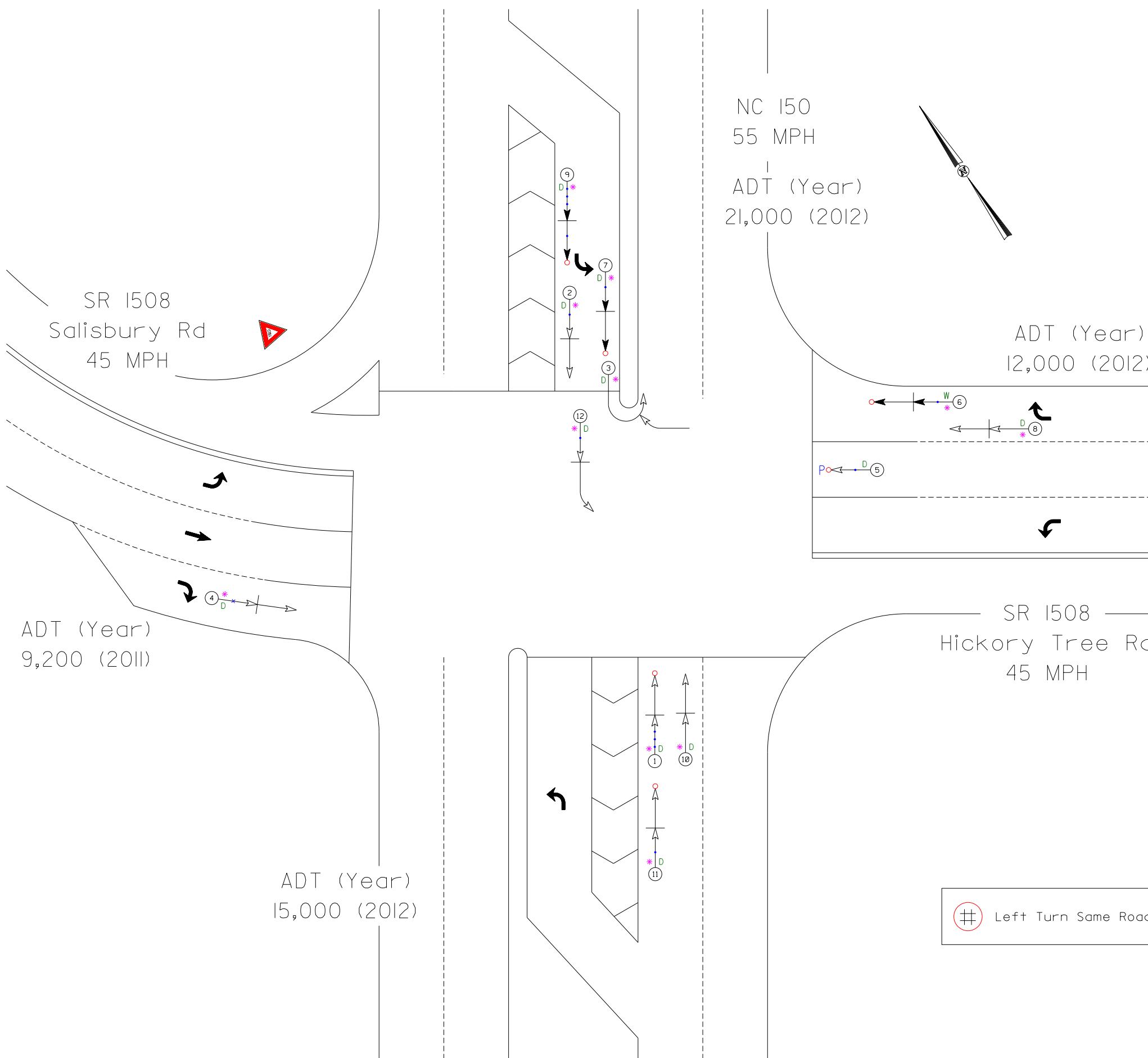

LEGEND

MOVING VEHICLE	ANGLE	9 MPH OR LESS	YIELD SIGN
PARKED VEHICLE	TURNING	10 MPH TO 19	ANIMAL
PARKING VEHICLE	BACKING	20 MPH TO 29	PEDESTRIAN
MOVABLE OBJECT	SIDESWIPE	30 MPH TO 39	BICYCLE
HEAD ON	INJURY	40 MPH TO 49	TRAIN
REAR END	FATALITY	50 MPH TO 59	DRIVER AT FAULT
RAN OFF ROAD	60 MPH TO 69	70 AND UP	DRY
DAYLIGHT CRASH	50 MPH TO 59	70 AND UP	WET
NIGHT CRASH	60 MPH TO 69	70 AND UP	ICY OR SNOWY
	SPEED UNKNOWN	70 AND UP	Other

SS# 09-07-207
Davidson County
After 2 Period
08/01/12 - 08/31/13

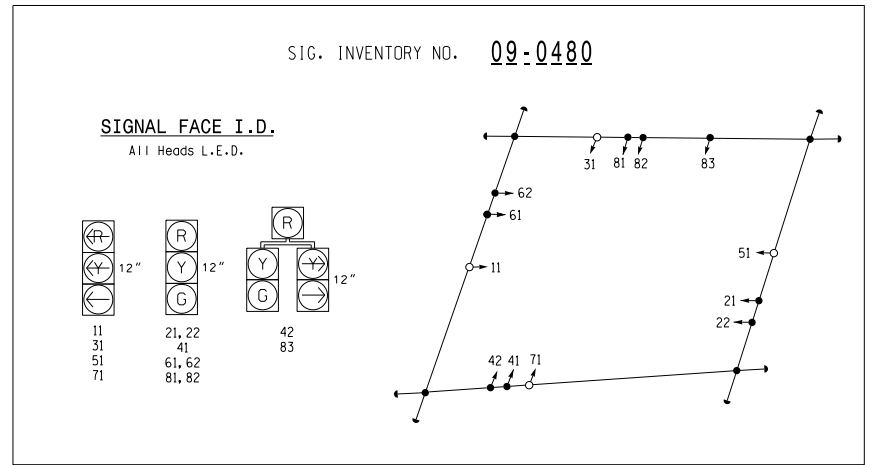

Left Turn Same Roadway (Target I)

N.C. DEPARTMENT of TRANSPORTATION
DIVISION of HIGHWAYS
TRANSPORTATION MOBILITY and SAFETY DIVISION

TRAFFIC SAFETY UNIT

Date: 11-1-13 Prepared By: Amy Faulkner, EI